

19" PROline 200 Series Wall Mounting Cabinets



Wall Mounting PROline 200 Series Cabinets 6U/7U/9U/12U/16U/20U G600xD450mm and G600xD600mm

Multi folded modular design clamped with screws, coated with RAL 7035 epoxy polyester powder.

Glass door at the front, with 4,0 mm dark coloured and EN 12150-1 compatible tempered secure glass with metal housing and a single point barrel locking.

Lockable side panels with special spring loaded pin system.

1 set of 19" front depth adjustable equipment mounting rails & 1 set of 19" rear fixed equipment mounting rails.

Three 60x210mm removable cable entry panels connected with micro joints available at the top, bottom and rear side of the cabinet.

Ventilation slots that can mount single or double fan modules for forced ventilation.

Wall mounted maximum load capacity up to 100 kg.

Wall mounting kit included.

Production Standards :

- ISO 9001:2015 - Quality Management System
- ISO 14001:2015 - Environmental Management System

Compliance:

- EN 61587-1 Mechanical structures for electronic equipment - Tests for IEC 60917 and IEC 60297 series
- Climatic and Environment: EN 61587-1/4.2, IEC60068-2-1, IEC60068-2-2, IEC60068-2-30
- Static Mechanical Load Lifting: EN 61587-1/5.2.1
- Static Mechanical Load Stiffness: EN 61587-1/5.2.2
- Dynamic Mechanical Load Vibration and Shock, Impact: EN61587-1/5.3.1, EN61587-1/5.3.3, IEC60068-2-6, IEC60068-2-27
- Earth Bond: EN61587-1/6.2
- Flammability: EN 61587-1/6.3
- Degrees of Protection Provided by Enclosures (Ip Code): IP20
- EN 13501-1+ A1- Epoxy Powder coated compliant to Fire classification of construction products and building elements -Part 1: Classification using data from reaction to fire tests
- Epoxy Powder coating tested as per EN ISO 9227 and ASTM B 117 Corrosion tests in artificial atmospheres - Salt spray tests; minimum 1000 hours
- EN ISO 2409 Paints and varnishes - Cross-cut test
- EN ISO 2178 Non-magnetic coatings on magnetic substrates -
- Measurement of coating thickness - Magnetic method
- RoHS Compliancy according to 2011/65/EU
- CE Compliant to EN 60950-1



19" PROline 200 Series Wall Mounting Cabinets

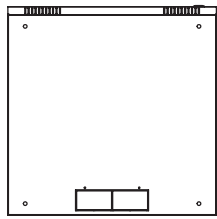

Bottom view

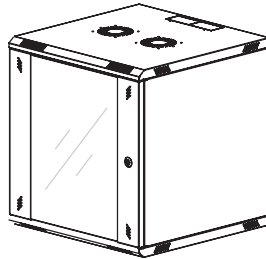

Isometric view

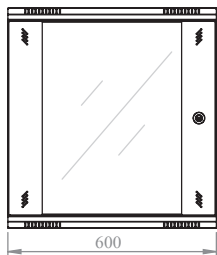

Front view

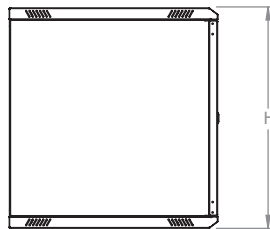

Side view

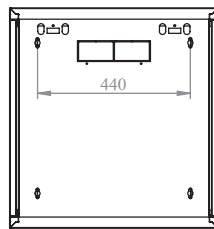

Rear view

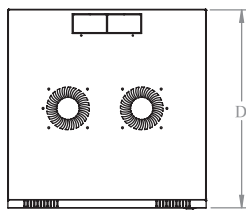

TOP VIEW

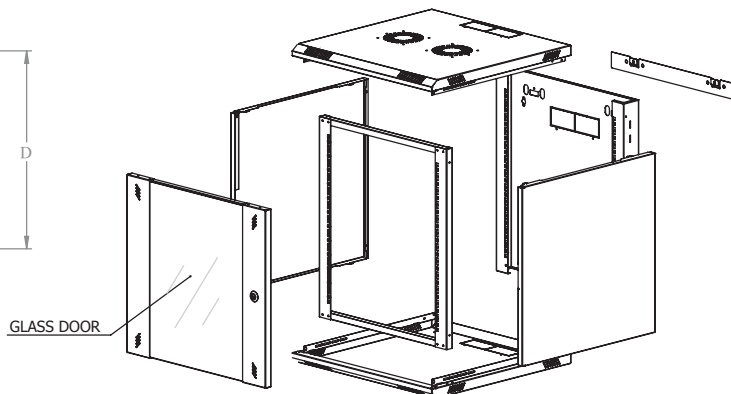

EXPLODED VIEW



PROline 200 Wall Mounting

Product Number	Dimensions WxDxH mm	Package Size WxDxH mm	Product Description
LN-PRB-06U6045-LG-A	600x450x367	650x490x383	6U 19" W600mm x D450mm Wall Mounting Cabinet
LN-PRB-07U6045-LG-A	600x450x423	650x490x439	7U 19" W600mm x D450mm Wall Mounting Cabinet
LN-PRB-09U6045-LG-A	600x450x500	650x490x516	9U 19" W600mm x D450mm Wall Mounting Cabinet
LN-PRB-12U6045-LG-A	600x450x633	650x490x649	12U 19" W600mm x D450mm Wall Mounting Cabinet
LN-PRB-16U6045-LG-A	600x450x812	650x490x828	16U 19" W600mm x D450mm Wall Mounting Cabinet
LN-PRB-20U6045-LG-A	600x450x988	650x490x1004	20U 19" W600mm x D450mm Wall Mounting Cabinet

PROline 200 Wall Mounting

Product Number	Dimensions WxDxH mm	Package Size WxDxH mm	Product Description
LN-PRB-06U6060-LG-A	600x600x367	650x650x383	6U 19" W600mm x D600mm Wall Mounting Cabinet
LN-PRB-06U6060-LG-A	600x600x423	650x650x439	7U 19" W600mm x D600mm Wall Mounting Cabinet
LN-PRB-09U6060-LG-A	600x600x500	650x650x516	9U 19" W600mm x D600mm Wall Mounting Cabinet
LN-PRB-12U6045-LG-A	600x600x633	650x650x649	12U 19" W600mm x D600mm Wall Mounting Cabinet
LN-PRB-16U6060-LG-A	600x600x812	650x650x828	16U 19" W600mm x D600mm Wall Mounting Cabinet
LN-PRB-20U6060-LG-A	600x600x988	650x650x1004	20U 19" W600mm x D600mm Wall Mounting Cabinet



* H length can be checked from the product dimensions.

ACCESSORIES

Fan Modules for wall mounting cabinets, plug and play without reconfiguration, available with on/off switches or automatic analog thermostat . Each fan has an air flow capacity of 2,3-3 cbm/min. Fan technical data: 18/17 W, 220/240 VAC, 50/60 Hz, 013/0,11 A,2300/3000 rpm 42 dB noise level, Fan lifetime span: 50.000 hours.



FAN MODULE ON/OFF SWITCHED BALL BEARING LONG LIFE FAN - 50.000 HOURS - FEATURES

Part Number	Category	Product Description
LN-FAN-ONF-1FWM-CC	Accessory	1 Fan Module on/off switched Wall Mounting Type
LN-FAN-ONF-2FWM-CC	Accessory	2 Fan Module on/off switched Wall Mounting Type

FAN MODULE THERMOSTAT SWITCHED BALL BEARING LONG LIFE FAN - 50.000 HOURS - FEATURES

Part Number	Category	Product Description
LN-FAN-THM-1FWM-CC	Accessory	1 Fan Module thermostat switched Wall Mounting Type
LN-FAN-THM-2FWM-CC	Accessory	2 Fan Module thermostat switched Wall Mounting Type

*CC= Color codification- Replace CC with BL for Black RAL 9005 Color- and Replace CC with LC for Light Grey RAL 7035 Color.

FAN MODULE ON/OFF SWITCHED BALL BEARING LONG LIFE FAN - 50.000 HOURS - ECONOMIC

Part Number	Category	Product Description
LN-FAN-BB-1FPR-CC	Accessory	1 way Fan Module On/off Switched
LN-FAN-BB-2FPR-CC	Accessory	2 way Fan Module On/off Switched

FAN MODULE THERMOSTAT CONTROLLED BALL BEARING LONG LIFE FAN - 50.000 HOURS - ECONOMIC

Part Number	Category	Product Description
LN-FAN-BB-1FPT-CC	Accessory	1 way Fan Module Thermostat Controlled
LN-FAN-BB-2FPT-CC	Accessory	2 way Fan Module Thermostat Controlled

*CC= Color codification- Replace CC with BL for Black RAL 9005 Color- and Replace CC with LC for Light Grey RAL 7035 Color.



ECONOMIC EXTENDABLE FAN MODULES - NO ANY METAL HOUSING - BALL BEARING LONG LIFE FAN - 50.000 HOURS - ECONOMIC+

Part Number	Group	Product Description
LN-FAN-HL-1FBB-M	Accessory	Single Fan - with Grill- 1,8meter Power Cable DIN49441 Schuko Plug and Extention Terminal Male - Ball Bearing Long life Fan
LN-FAN-HL-1FBB-E	Accessory	Single Fan - with Grill- Extention Terminal Female - Ball Bearing Long life Fan

*** LN-FAN-HL-1FBB-E is Just a fan for making cabinet equipped with 2 fans- used with main product LN-FAN-HL-1FBB-M and add the extention fan

SNAP IN and QUICK TERMINAL GROUNDING CABLE KIT

Part Number	Group	Product Description
LN-PRB-TPR-01	Accessory	Snap in 3pcs Grounding Terminals and 3pcs 20cm long Plug in Type Grounding Cables